

3208 A-2Z SKF

Angular contact ball bearings

TYPE: Ball bearings, Angular contact ball bearing, Double row, Contact angle 30°, Gap seals on both side

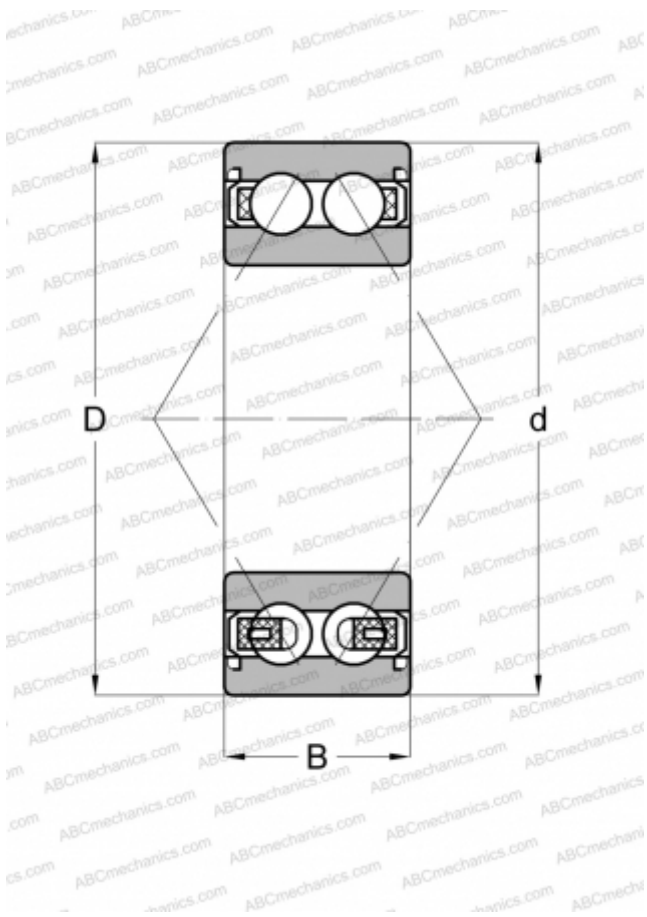

Technical specification

DIMENSIONS, MM

d	40,000
D	80,000
B	30,200

WEIGHT, KG

0,570

MANUFACTURER

[SKF](#)

INTERCHANGE

ABC	3208 BD 2Z TVH
FAG	3208 BD 2Z TVH

CALCULATION DATA

Basic dynamic load rating, C	47,500 kN
Basic static load rating, Co	34,000 kN
Fatigue load limit, Pu	1,430 kN
Reference speed	8000 r/min
Limiting speed	5600 r/min