

3210 A-2Z SKF

Angular contact ball bearings

TYPE: Ball bearings, Angular contact ball bearing, Double row, Contact angle 30°, Gap seals on both side

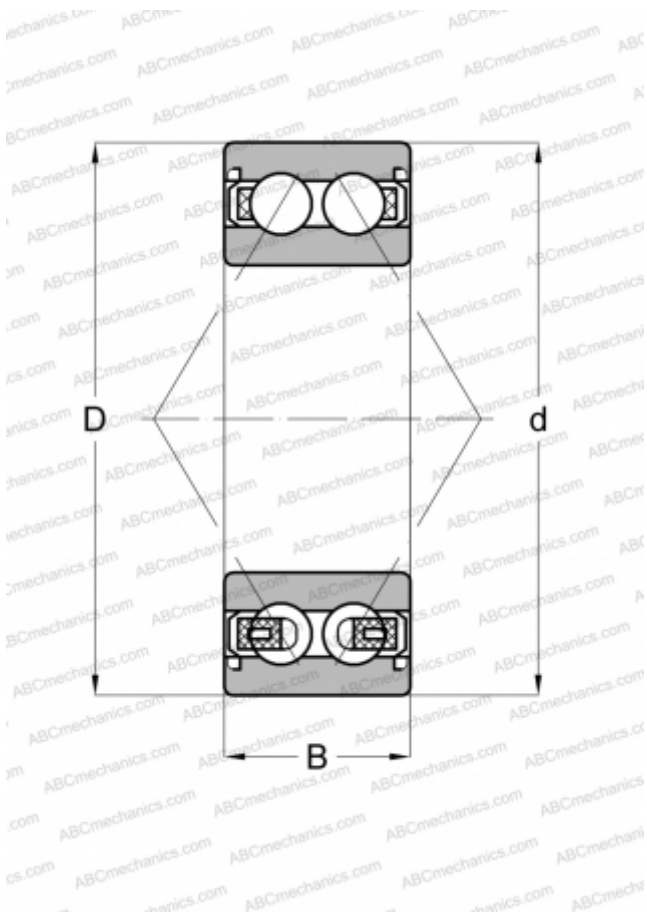

Technical specification

DIMENSIONS, MM

d	50,000
D	90,000
B	30,200

WEIGHT, KG

0,650

MANUFACTURER

[SKF](#)

INTERCHANGE

ABC	3210 BD 2Z TVH
FAG	3210 BD 2Z TVH

CALCULATION DATA

Basic dynamic load rating, C	51,000 kN
Basic static load rating, Co	39,000 kN
Fatigue load limit, Pu	1,660 kN
Reference speed	7000 r/min
Limiting speed	4800 r/min