

3215 A-2Z SKF

Angular contact ball bearings

TYPE: Ball bearings, Angular contact ball bearing, Double row, Contact angle 30°, Gap seals on both side

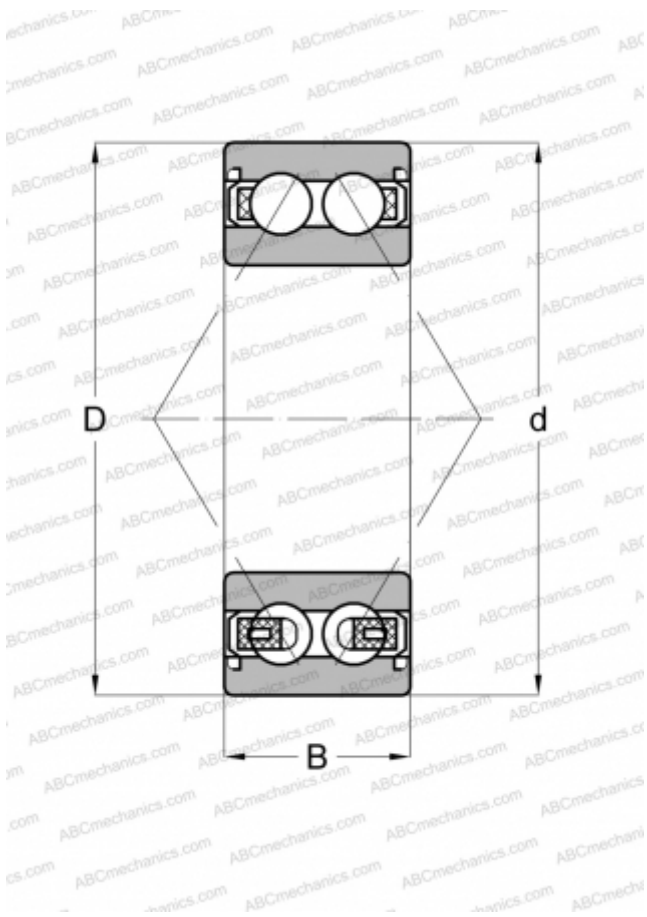

Technical specification

DIMENSIONS, MM

d	75,000
D	130,000
B	41,300

WEIGHT, KG

2,100

MANUFACTURER

[SKF](#)

INTERCHANGE

ABC	3215 A 2Z
-----	---------------------------

CALCULATION DATA

Basic dynamic load rating, C	95,600 kN
Basic static load rating, Co	88,000 kN
Fatigue load limit, Pu	3,750 kN
Reference speed	4500 r/min