

1204 EKTN9 SKF

Self-aligning ball bearings

TYPE: Ball bearings, Radial ball bearings, Double row, spherical, With tapered bore, With adapter sleeve

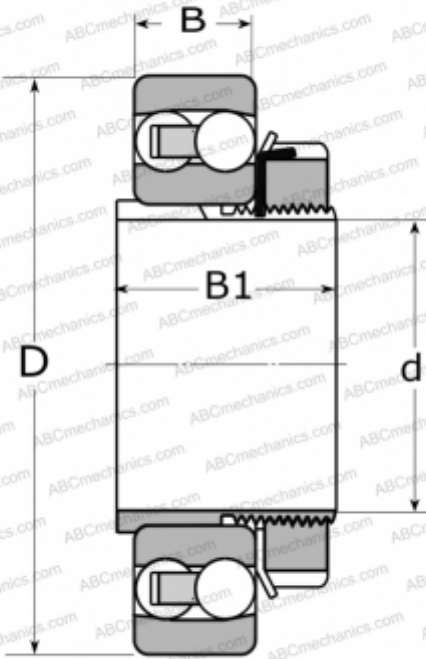

Technical specification

DIMENSIONS, MM

d	17,000
D	47,000
B	14,000
B1	24,000

WEIGHT, KG

0,160

MANUFACTURER

[SKF](#)

CALCULATION DATA

Basic dynamic load rating, C	12,700 kN
Basic static load rating, Co	3,400 kN
Fatigue load limit, Pu	0,180 kN
Reference speed	32000 r/min
Limiting speed	20000 r/min

ASSOCIATED PRODUCTS

H 204