

1205 EKTN9 SKF

Self-aligning ball bearings

TYPE: Ball bearings, Radial ball bearings, Double row, spherical, With tapered bore, With adapter sleeve

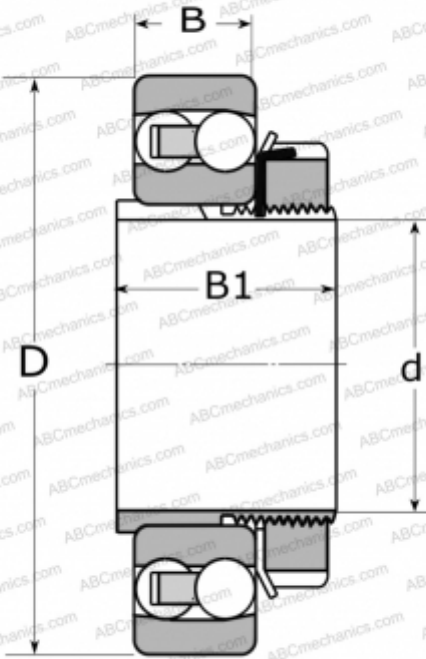

Technical specification

DIMENSIONS, MM

d	20,000
D	52,000
B	15,000
B1	26,000

WEIGHT, KG

0,210

MANUFACTURER

[SKF](#)

CALCULATION DATA

Basic dynamic load rating, C	14,300 kN
Basic static load rating, Co	4,000 kN
Fatigue load limit, Pu	0,210 kN
Reference speed	28000 r/min
Limiting speed	18000 r/min

ASSOCIATED PRODUCTS

H 205