

1306 EKTN9 SKF

Self-aligning ball bearings

TYPE: Ball bearings, Radial ball bearings, Double row, spherical, With tapered bore, With adapter sleeve

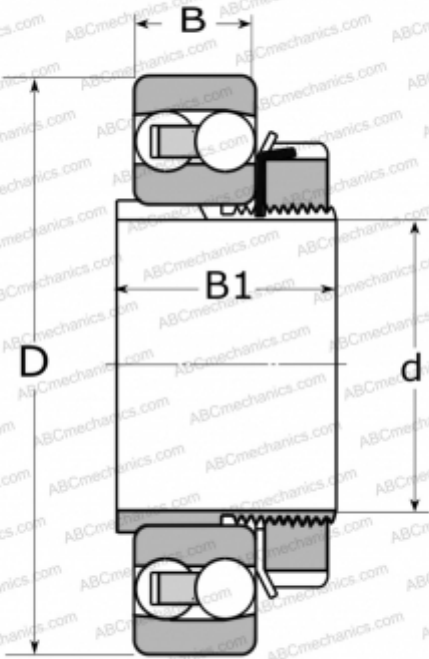

Technical specification

DIMENSIONS, MM

d	25,000
D	72,000
B	19,000
B1	27,000

WEIGHT, KG

0,490

MANUFACTURER

[SKF](#)

CALCULATION DATA

Basic dynamic load rating, C	22,500 kN
Basic static load rating, Co	6,800 kN
Fatigue load limit, Pu	0,360 kN
Reference speed	19000 r/min
Limiting speed	13000 r/min

ASSOCIATED PRODUCTS

H 306