

2306 K SKF

Self-aligning ball bearings

TYPE: Ball bearings, Radial ball bearings, Double row, spherical, With tapered bore, With adapter sleeve

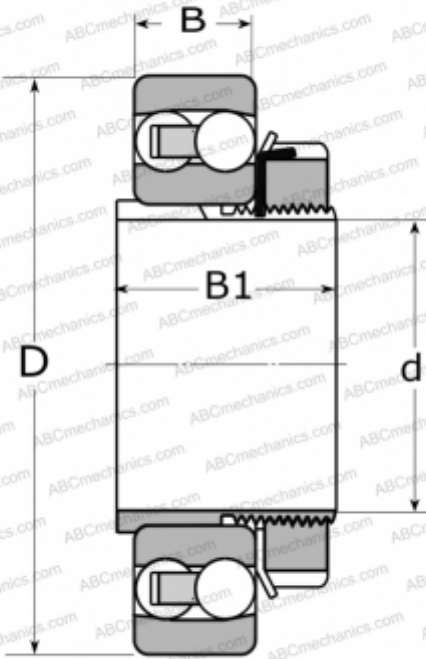

Technical specification

DIMENSIONS, MM

d	25,000
D	72,000
B	27,000
B1	38,000

WEIGHT, KG

0,610

MANUFACTURER

[SKF](#)

CALCULATION DATA

Basic dynamic load rating, C	31,200 kN
Basic static load rating, Co	8,800 kN
Fatigue load limit, Pu	0,450 kN
Reference speed	18000 r/min
Limiting speed	13000 r/min

ASSOCIATED PRODUCTS

H 2306