

## 1207 EKTN9 SKF

Self-aligning ball bearings

TYPE: Ball bearings, Radial ball bearings, Double row, spherical, With tapered bore, With adapter sleeve

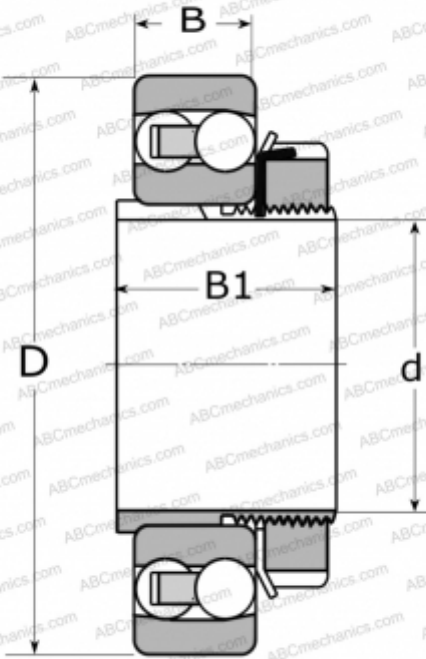

### Technical specification

#### DIMENSIONS, MM

d	30,000
D	72,000
B	17,000
B1	29,000

#### WEIGHT, KG

0,440

#### MANUFACTURER

[SKF](#)

#### CALCULATION DATA

Basic dynamic load rating, C	19,000 kN
Basic static load rating, Co	6,000 kN
Fatigue load limit, Pu	0,310 kN
Reference speed	20000 r/min
Limiting speed	13000 r/min

#### ASSOCIATED PRODUCTS

H 207