

2207 EKTN9 SKF

Self-aligning ball bearings

TYPE: Ball bearings, Radial ball bearings, Double row, spherical, With tapered bore, With adapter sleeve

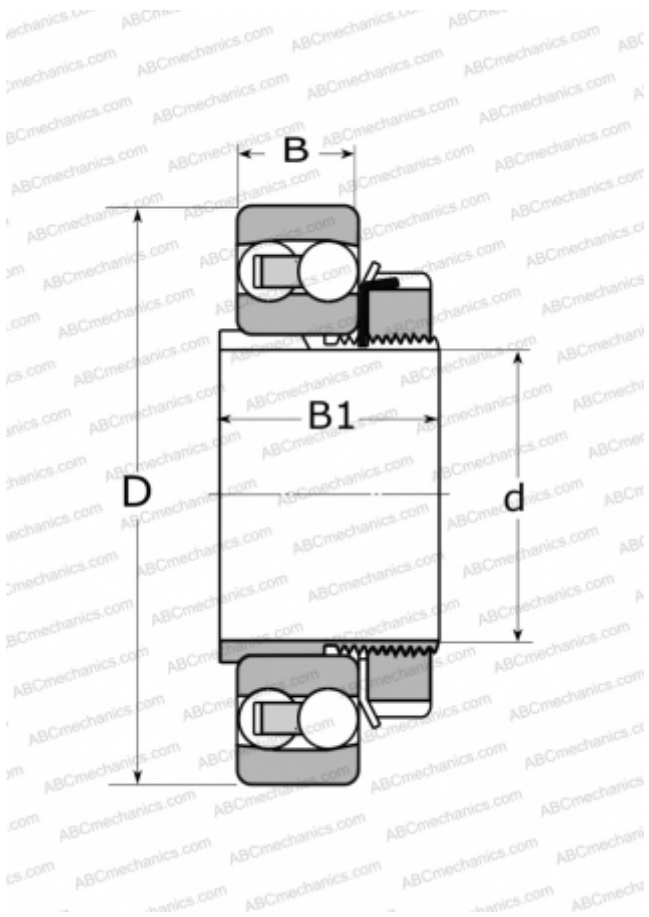

Technical specification

DIMENSIONS, MM

d	30,000
D	72,000
B	23,000
B1	35,000

WEIGHT, KG

0,540

MANUFACTURER

[SKF](#)

CALCULATION DATA

Basic dynamic load rating, C	30,700 kN
Basic static load rating, Co	8,800 kN
Fatigue load limit, Pu	0,460 kN
Reference speed	18000 r/min
Limiting speed	12000 r/min

ASSOCIATED PRODUCTS

H 307