

1308 EKTN9 SKF

Self-aligning ball bearings

TYPE: Ball bearings, Radial ball bearings, Double row, spherical, With tapered bore, With adapter sleeve

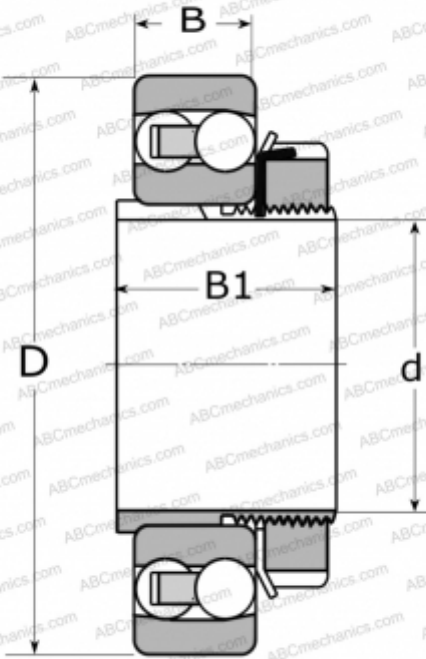

Technical specification

DIMENSIONS, MM

d	35,000
D	90,000
B	23,000
B1	36,000

WEIGHT, KG

0,850

MANUFACTURER

[SKF](#)

CALCULATION DATA

Basic dynamic load rating, C	33,800 kN
Basic static load rating, Co	11,200 kN
Fatigue load limit, Pu	0,570 kN
Reference speed	14000 r/min
Limiting speed	9500 r/min

ASSOCIATED PRODUCTS

H 308