

## 1209 EKTN9 SKF

Self-aligning ball bearings

TYPE: Ball bearings, Radial ball bearings, Double row, spherical, With tapered bore, With adapter sleeve

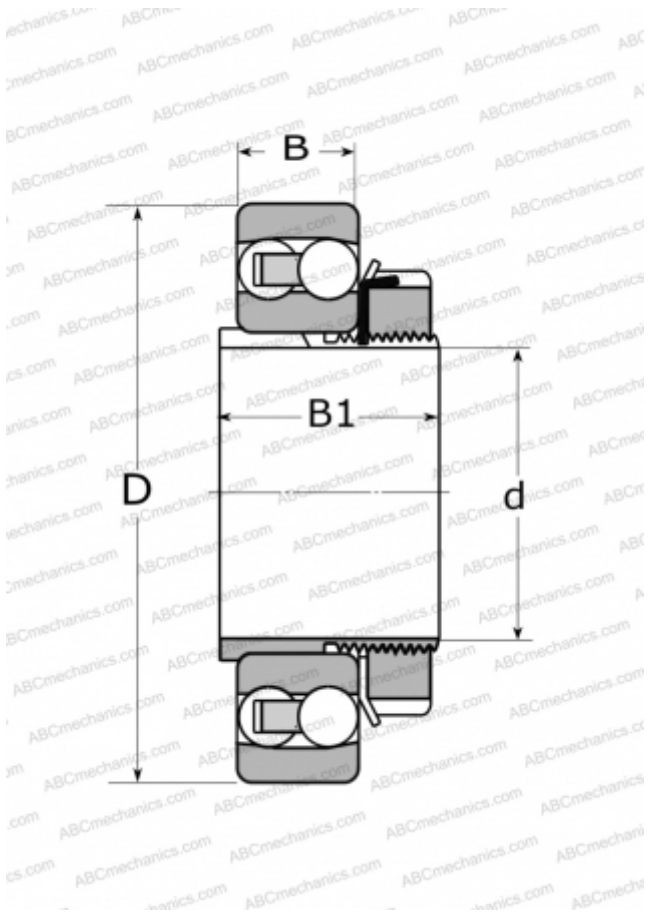

### Technical specification

#### DIMENSIONS, MM

d	40,000
D	85,000
B	19,000
B1	33,000

#### WEIGHT, KG

0,680

#### MANUFACTURER

[SKF](#)

#### CALCULATION DATA

Basic dynamic load rating, C	22,900 kN
Basic static load rating, Co	7,800 kN
Fatigue load limit, Pu	0,400 kN
Reference speed	17000 r/min
Limiting speed	11000 r/min

#### ASSOCIATED PRODUCTS

H 209