

1309 EKTN9 SKF

Self-aligning ball bearings

TYPE: Ball bearings, Radial ball bearings, Double row, spherical, With tapered bore, With adapter sleeve

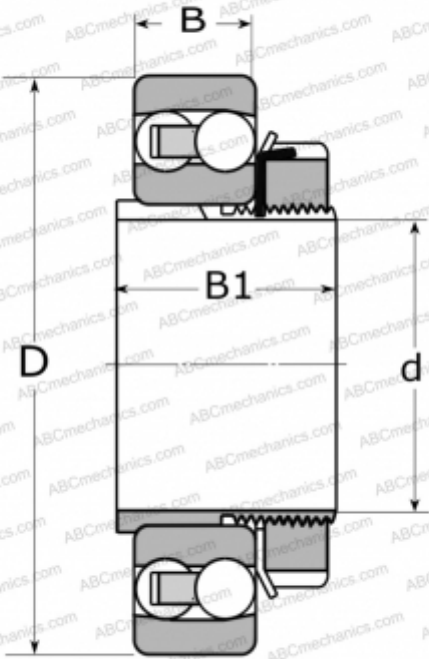

Technical specification

DIMENSIONS, MM

d	40,000
D	100,000
B	25,000
B1	39,000

WEIGHT, KG

1,200

MANUFACTURER

[SKF](#)

CALCULATION DATA

Basic dynamic load rating, C	39,000 kN
Basic static load rating, Co	13,400 kN
Fatigue load limit, Pu	0,700 kN
Reference speed	12000 r/min
Limiting speed	8500 r/min

ASSOCIATED PRODUCTS

H 309