

## 2309 EKTN9 SKF

Self-aligning ball bearings

TYPE: Ball bearings, Radial ball bearings, Double row, spherical, With tapered bore, With adapter sleeve

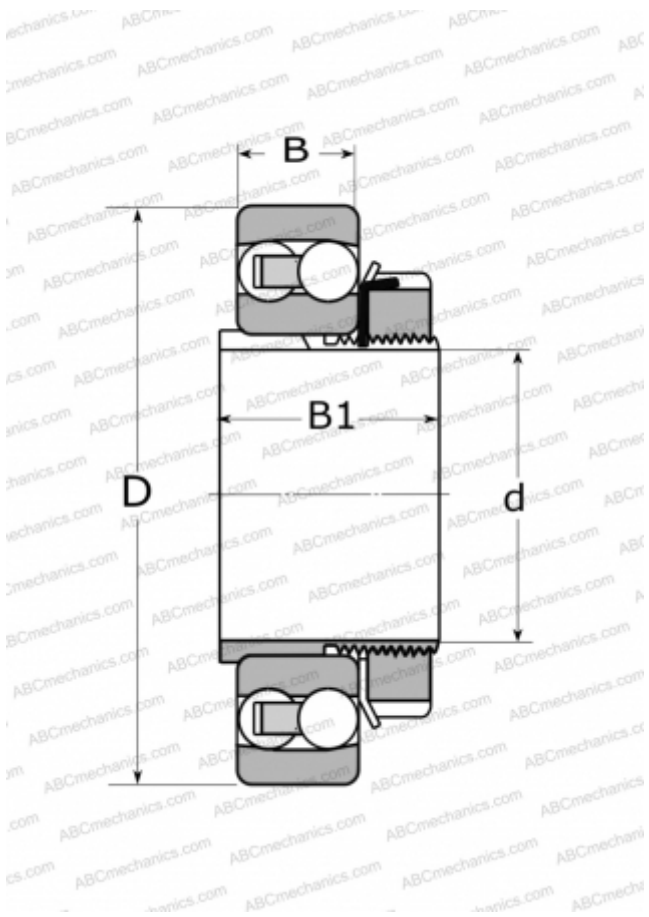

### Technical specification

#### DIMENSIONS, MM

d	40,000
D	100,000
B	36,000
B1	50,000

#### WEIGHT, KG

1,400

#### MANUFACTURER

[SKF](#)

#### CALCULATION DATA

Basic dynamic load rating, C	63,700 kN
Basic static load rating, Co	19,300 kN
Fatigue load limit, Pu	1,000 kN
Reference speed	13000 r/min
Limiting speed	9000 r/min

#### ASSOCIATED PRODUCTS

H 2309