

## 1310 EKTN9 SKF

Self-aligning ball bearings

TYPE: Ball bearings, Radial ball bearings, Double row, spherical, With tapered bore, With adapter sleeve

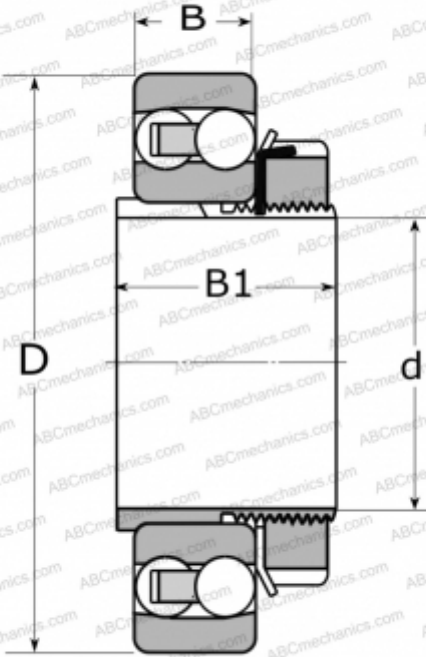

### Technical specification

#### DIMENSIONS, MM

d	45,000
D	110,000
B	27,000
B1	42,000

#### WEIGHT, KG

1,450

#### MANUFACTURER

[SKF](#)

#### CALCULATION DATA

Basic dynamic load rating, C	43,600 kN
Basic static load rating, Co	14,000 kN
Fatigue load limit, Pu	0,720 kN
Reference speed	12000 r/min
Limiting speed	8000 r/min

#### ASSOCIATED PRODUCTS

H 310