

1211 EKTN9 SKF

Self-aligning ball bearings

TYPE: Ball bearings, Radial ball bearings, Double row, spherical, With tapered bore, With adapter sleeve

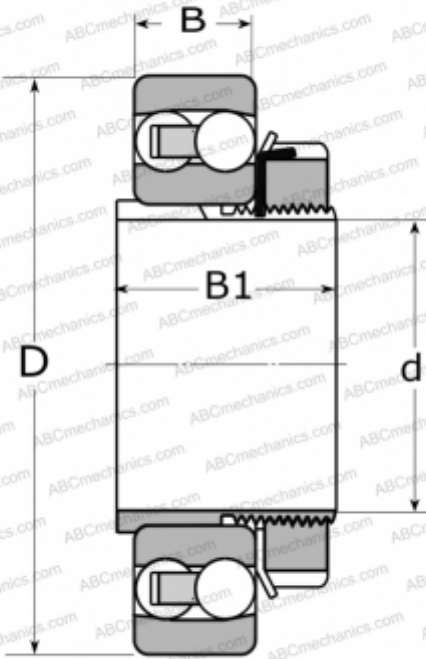

Technical specification

DIMENSIONS, MM

d	50,000
D	100,000
B	21,000
B1	37,000

WEIGHT, KG

0,990

MANUFACTURER

[SKF](#)

CALCULATION DATA

Basic dynamic load rating, C	27,600 kN
Basic static load rating, Co	10,600 kN
Fatigue load limit, Pu	0,540 kN
Reference speed	14000 r/min
Limiting speed	9000 r/min

ASSOCIATED PRODUCTS

H 211