

2212 EKTN9 SKF

Self-aligning ball bearings

TYPE: Ball bearings, Radial ball bearings, Double row, spherical, With tapered bore, With adapter sleeve

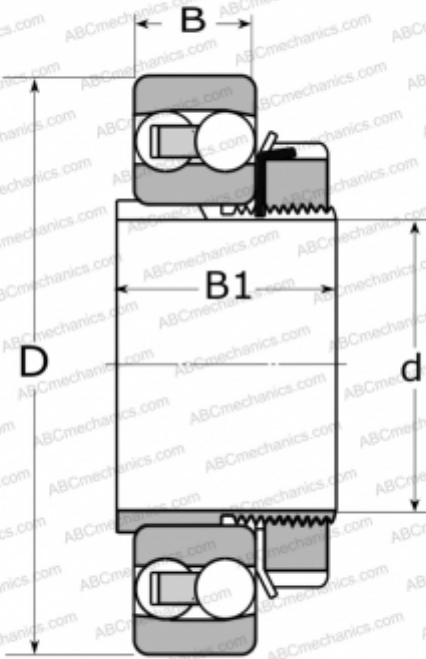

Technical specification

DIMENSIONS, MM

d	55,000
D	110,000
B	28,000
B1	47,000

WEIGHT, KG

1,450

MANUFACTURER

[SKF](#)

CALCULATION DATA

Basic dynamic load rating, C	48,800 kN
Basic static load rating, Co	17,000 kN
Fatigue load limit, Pu	0,880 kN
Reference speed	11000 r/min
Limiting speed	8000 r/min

ASSOCIATED PRODUCTS

H 312