

2213 EKTN9 SKF

Self-aligning ball bearings

TYPE: Ball bearings, Radial ball bearings, Double row, spherical, With tapered bore, With adapter sleeve

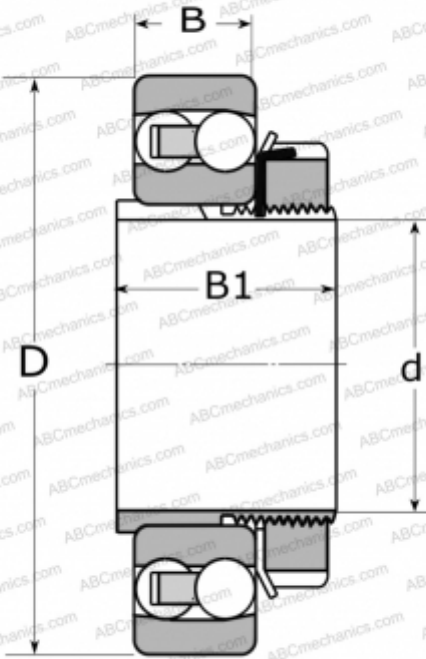

Technical specification

DIMENSIONS, MM

d	60,000
D	120,000
B	31,000
B1	50,000

WEIGHT, KG

1,800

MANUFACTURER

[SKF](#)

CALCULATION DATA

Basic dynamic load rating, C	57,200 kN
Basic static load rating, Co	20,000 kN
Fatigue load limit, Pu	1,020 kN
Reference speed	10000 r/min
Limiting speed	7000 r/min

ASSOCIATED PRODUCTS

H 313