

1216 K SKF

Self-aligning ball bearings

TYPE: Ball bearings, Radial ball bearings, Double row, spherical, With tapered bore, With adapter sleeve

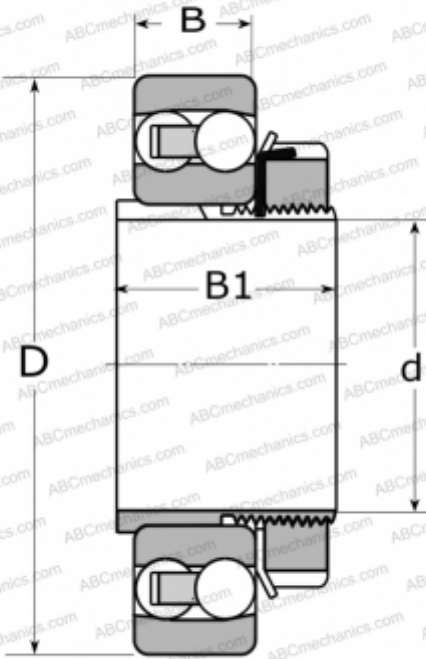

Technical specification

DIMENSIONS, MM

d	70,000
D	140,000
B	26,000
B1	46,000

WEIGHT, KG

2,400

MANUFACTURER

[SKF](#)

CALCULATION DATA

Basic dynamic load rating, C	39,700 kN
Basic static load rating, Co	17,000 kN
Fatigue load limit, Pu	0,830 kN
Reference speed	9500 r/min
Limiting speed	6000 r/min

ASSOCIATED PRODUCTS

H 216