

2216 EKTN9 SKF

Self-aligning ball bearings

TYPE: Ball bearings, Radial ball bearings, Double row, spherical, With tapered bore, With adapter sleeve

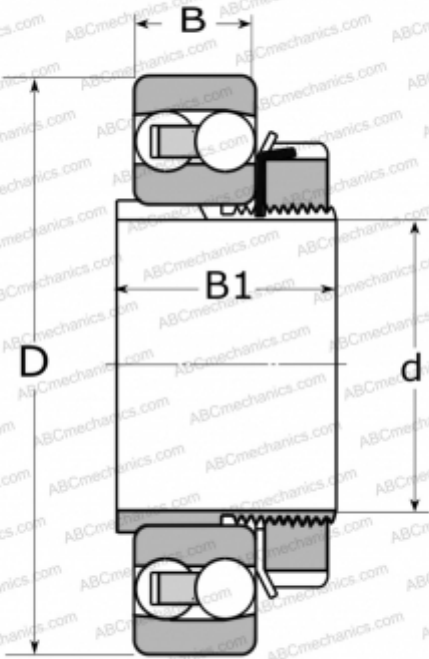

Technical specification

DIMENSIONS, MM

d	70,000
D	140,000
B	33,000
B1	59,000

WEIGHT, KG

2,850

MANUFACTURER

[SKF](#)

CALCULATION DATA

Basic dynamic load rating, C	65,000 kN
Basic static load rating, Co	25,500 kN
Fatigue load limit, Pu	1,250 kN
Reference speed	8500 r/min
Limiting speed	6000 r/min

ASSOCIATED PRODUCTS

H 316