

1316 K SKF

Self-aligning ball bearings

TYPE: Ball bearings, Radial ball bearings, Double row, spherical, With tapered bore, With adapter sleeve

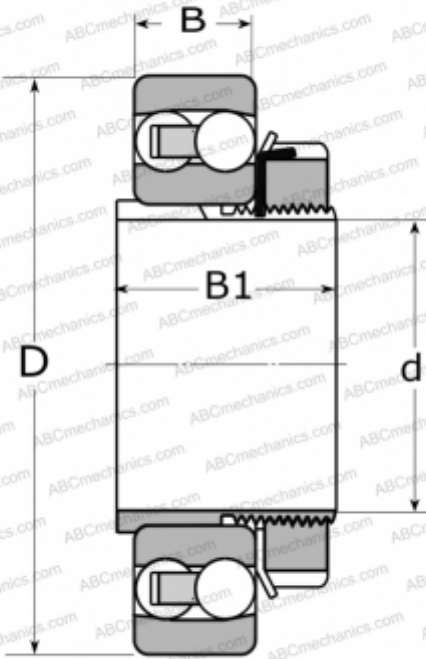

Technical specification

DIMENSIONS, MM

d	70,000
D	170,000
B	39,000
B1	59,000

WEIGHT, KG

5,000

MANUFACTURER

[SKF](#)

CALCULATION DATA

Basic dynamic load rating, C	88,400 kN
Basic static load rating, Co	33,500 kN
Fatigue load limit, Pu	1,500 kN
Reference speed	7500 r/min
Limiting speed	5300 r/min

ASSOCIATED PRODUCTS

H 316