

1217 K SKF

Self-aligning ball bearings

TYPE: Ball bearings, Radial ball bearings, Double row, spherical, With tapered bore, With adapter sleeve

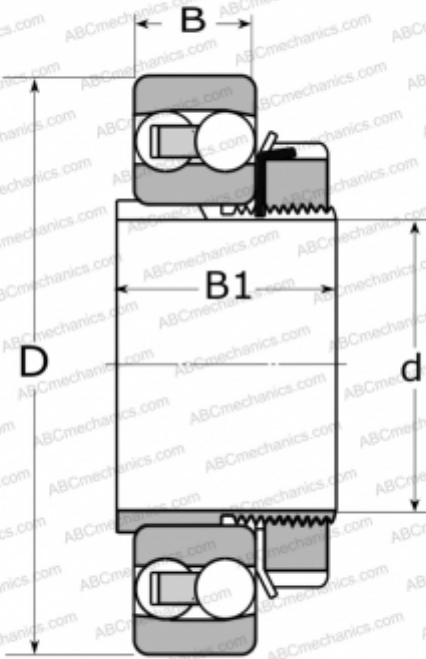

Technical specification

DIMENSIONS, MM

d	75,000
D	150,000
B	28,000
B1	50,000

WEIGHT, KG

2,950

MANUFACTURER

[SKF](#)

CALCULATION DATA

Basic dynamic load rating, C	48,800 kN
Basic static load rating, Co	20,800 kN
Fatigue load limit, Pu	0,980 kN
Reference speed	9000 r/min
Limiting speed	5600 r/min

ASSOCIATED PRODUCTS

H 217