

2217 K SKF

Self-aligning ball bearings

TYPE: Ball bearings, Radial ball bearings, Double row, spherical, With tapered bore, With adapter sleeve

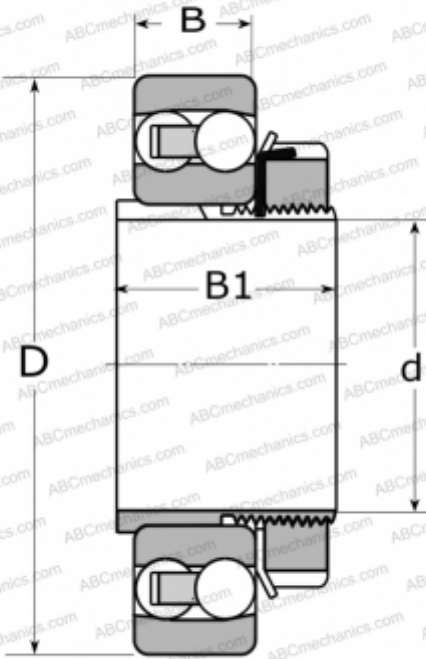

Technical specification

DIMENSIONS, MM

d	75,000
D	150,000
B	36,000
B1	63,000

WEIGHT, KG

3,300

MANUFACTURER

[SKF](#)

CALCULATION DATA

Basic dynamic load rating, C	58,500 kN
Basic static load rating, Co	23,600 kN
Fatigue load limit, Pu	1,120 kN
Reference speed	8000 r/min
Limiting speed	5600 r/min

ASSOCIATED PRODUCTS

H 317