

1317 K SKF

Self-aligning ball bearings

TYPE: Ball bearings, Radial ball bearings, Double row, spherical, With tapered bore, With adapter sleeve

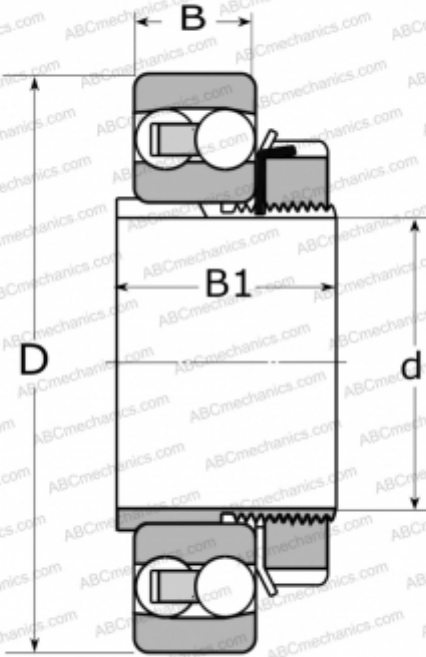

Technical specification

DIMENSIONS, MM

d	75,000
D	180,000
B	41,000
B1	63,000

WEIGHT, KG

6,000

MANUFACTURER

[SKF](#)

CALCULATION DATA

Basic dynamic load rating, C	97,500 kN
Basic static load rating, Co	38,000 kN
Fatigue load limit, Pu	1,700 kN
Reference speed	7000 r/min
Limiting speed	4800 r/min

ASSOCIATED PRODUCTS

H 317