

2218 K SKF

Self-aligning ball bearings

TYPE: Ball bearings, Radial ball bearings, Double row, spherical, With tapered bore, With adapter sleeve

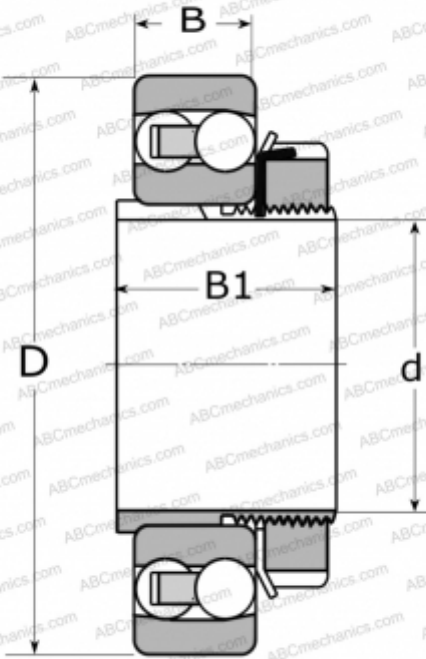

Technical specification

DIMENSIONS, MM

d	80,000
D	160,000
B	40,000
B1	65,000

WEIGHT, KG

5,500

MANUFACTURER

[SKF](#)

CALCULATION DATA

Basic dynamic load rating, C	70,200 kN
Basic static load rating, Co	28,500 kN
Fatigue load limit, Pu	1,320 kN
Reference speed	7500 r/min
Limiting speed	5300 r/min

ASSOCIATED PRODUCTS

H 318