

## 1224 KM SKF

Self-aligning ball bearings

TYPE: Ball bearings, Radial ball bearings, Double row, spherical, With tapered bore, With adapter sleeve

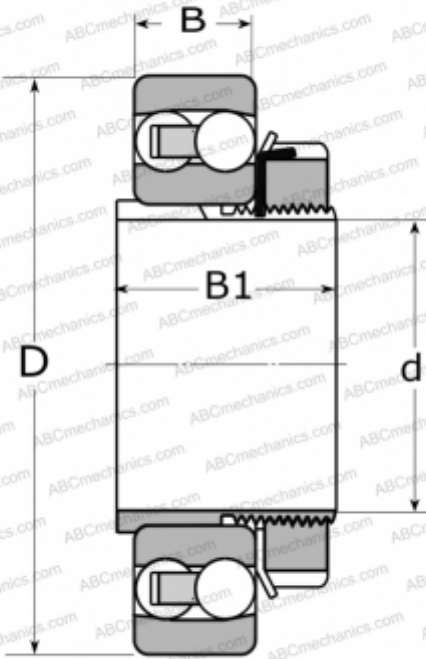

### Technical specification

#### DIMENSIONS, MM

d	110,000
D	215,000
B	42,000
B1	72,000

#### WEIGHT, KG

8,300

#### MANUFACTURER

[SKF](#)

#### CALCULATION DATA

Basic dynamic load rating, C	119,000 kN
Basic static load rating, Co	53,000 kN
Fatigue load limit, Pu	2,120 kN
Reference speed	6300 r/min
Limiting speed	4000 r/min

#### ASSOCIATED PRODUCTS

H 3024