

2208 E-2RS1KTN9 SKF

Self-aligning ball bearings

TYPE: Ball bearings, Radial ball bearings, Double row, spherical, With tapered bore, With adapter sleeve, seals 2RS

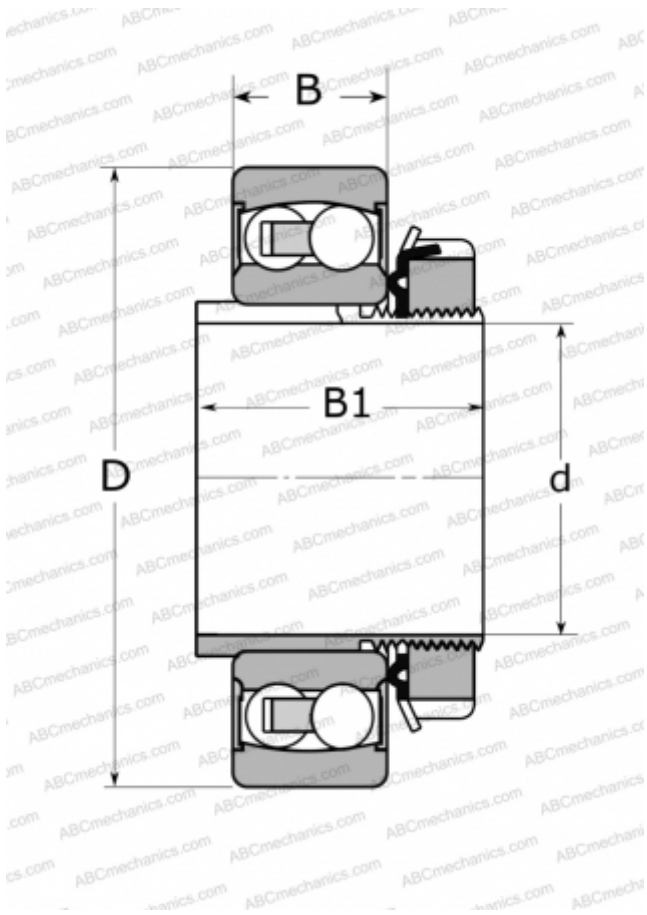

Technical specification

DIMENSIONS, MM

d	35,000
D	80,000
B	23,000
B1	36,000

WEIGHT, KG

0,670

MANUFACTURER

[SKF](#)

CALCULATION DATA

Basic dynamic load rating, C	19,900 kN
Basic static load rating, Co	6,950 kN
Fatigue load limit, Pu	0,360 kN
Limiting speed	5600 r/min

ASSOCIATED PRODUCTS

H 308 C