

## 2210 E-2RS1KTN9 SKF

Self-aligning ball bearings

TYPE: Ball bearings, Radial ball bearings, Double row, spherical, With tapered bore, With adapter sleeve, seals 2RS

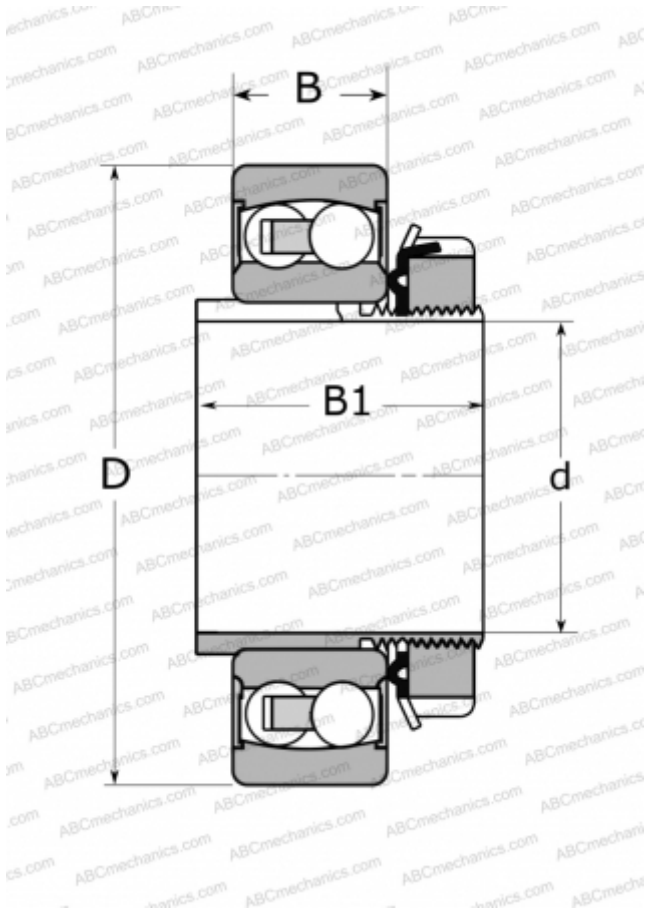

### Technical specification

#### DIMENSIONS, MM

d	45,000
D	90,000
B	23,000
B1	42,000

#### WEIGHT, KG

0,840

#### MANUFACTURER

[SKF](#)

#### CALCULATION DATA

Basic dynamic load rating, C	22,900 kN
Basic static load rating, Co	8,150 kN
Fatigue load limit, Pu	0,420 kN
Limiting speed	4800 r/min

#### ASSOCIATED PRODUCTS

H 310 C