

## 2213 E-2RS1KTN9 SKF

Self-aligning ball bearings

TYPE: Ball bearings, Radial ball bearings, Double row, spherical, With tapered bore, With adapter sleeve, seals 2RS

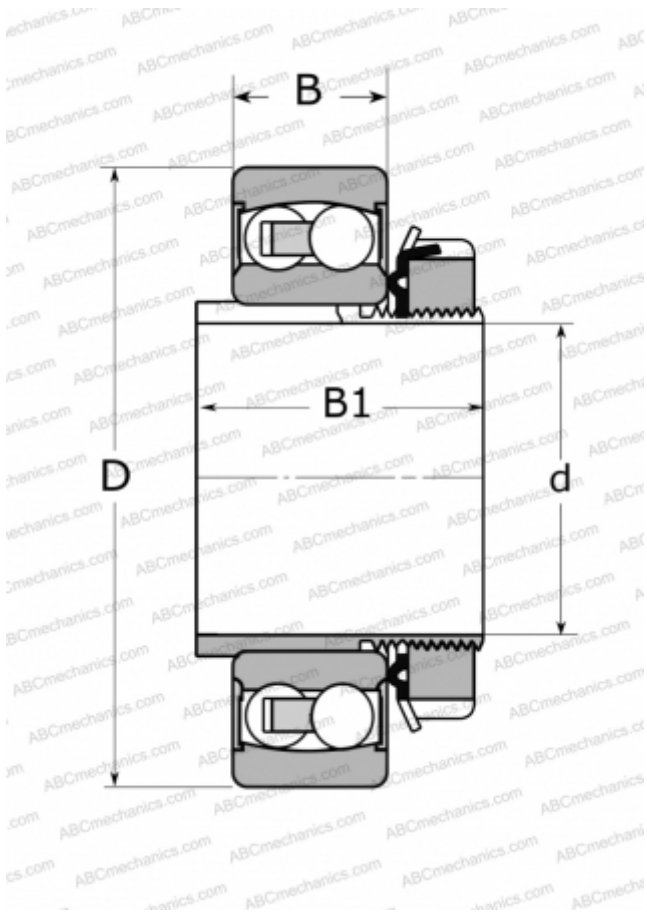

### Technical specification

#### DIMENSIONS, MM

d	60,000
D	120,000
B	31,000
B1	50,000

#### WEIGHT, KG

1,750

#### MANUFACTURER

[SKF](#)

#### CALCULATION DATA

Basic dynamic load rating, C	35,100 kN
Basic static load rating, Co	14,000 kN
Fatigue load limit, Pu	0,720 kN
Limiting speed	3600 r/min

#### ASSOCIATED PRODUCTS

H 313 C