

32220T108 J2/DB SKF

Tapered roller bearings

TYPE: Roller bearings, Tapered, Single row, matched bearings, Back-to-back (SKF)

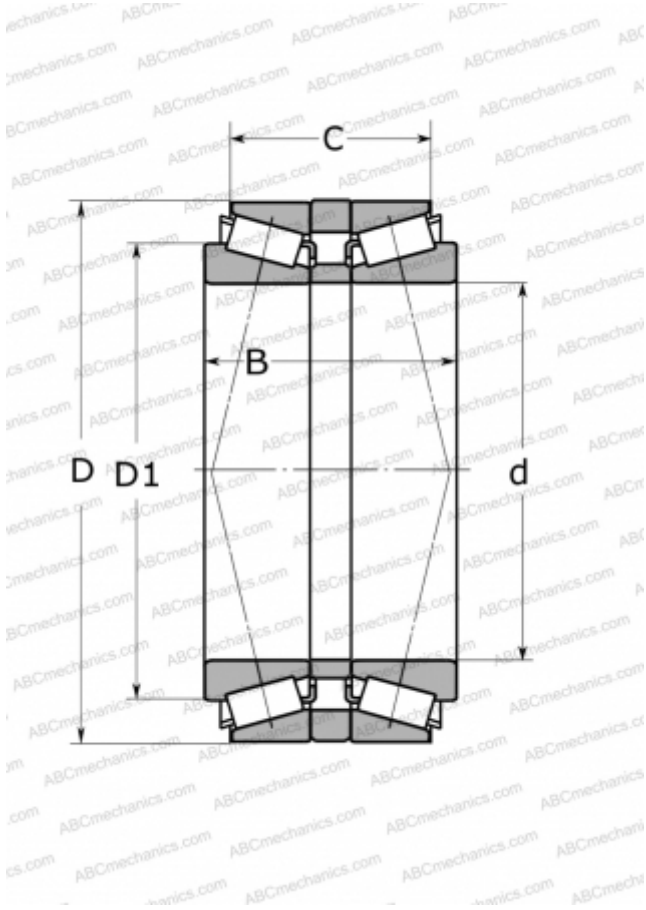

Technical specification

DIMENSIONS, MM

d	100,000
D	180,000
D1	135,000
B	108,000
C	88,000

WEIGHT, KG

10,500

MANUFACTURER

[SKF](#)

CALCULATION DATA

Basic dynamic load rating, C	539,000 kN
Basic static load rating, Co	880,000 kN
Fatigue load limit, Pu	96,500 kN
Reference speed	2200 r/min
Limiting speed	3600 r/min