

32024T84 X/QDBC200 SKF

Tapered roller bearings

TYPE: Roller bearings, Tapered, Single row, matched bearings, Back-to-back (SKF)

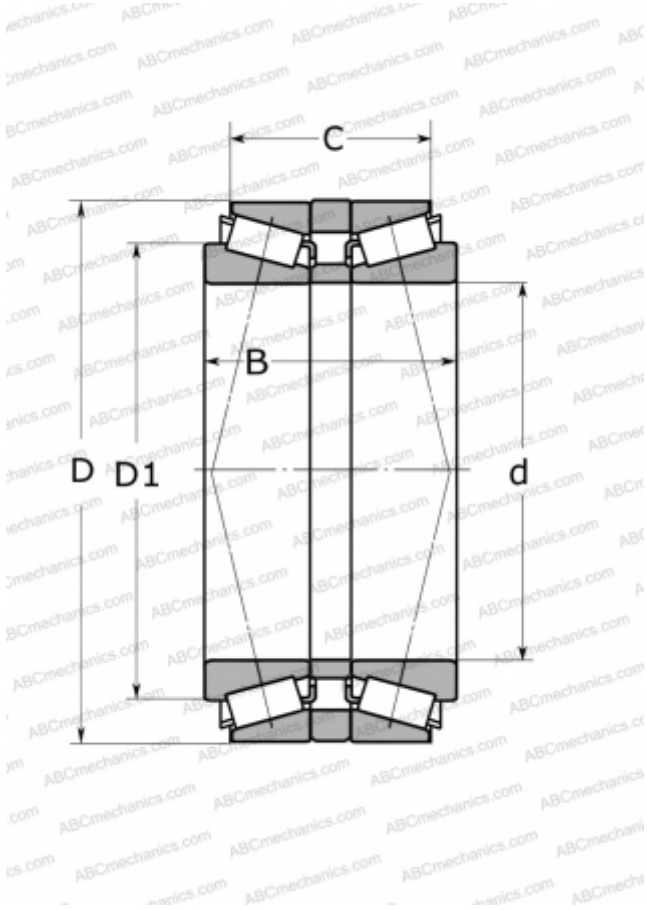

Technical specification

DIMENSIONS, MM

d	120,000
D	180,000
D1	150,000
B	84,000
C	66,000

WEIGHT, KG

7,000

MANUFACTURER

[SKF](#)

CALCULATION DATA

Basic dynamic load rating, C	418,000 kN
Basic static load rating, Co	830,000 kN
Fatigue load limit, Pu	88,000 kN
Reference speed	2000 r/min
Limiting speed	3400 r/min