

## 32224T146 J2/DB31C210 SKF

Tapered roller bearings

TYPE: Roller bearings, Tapered, Single row, matched bearings, Back-to-back (SKF)

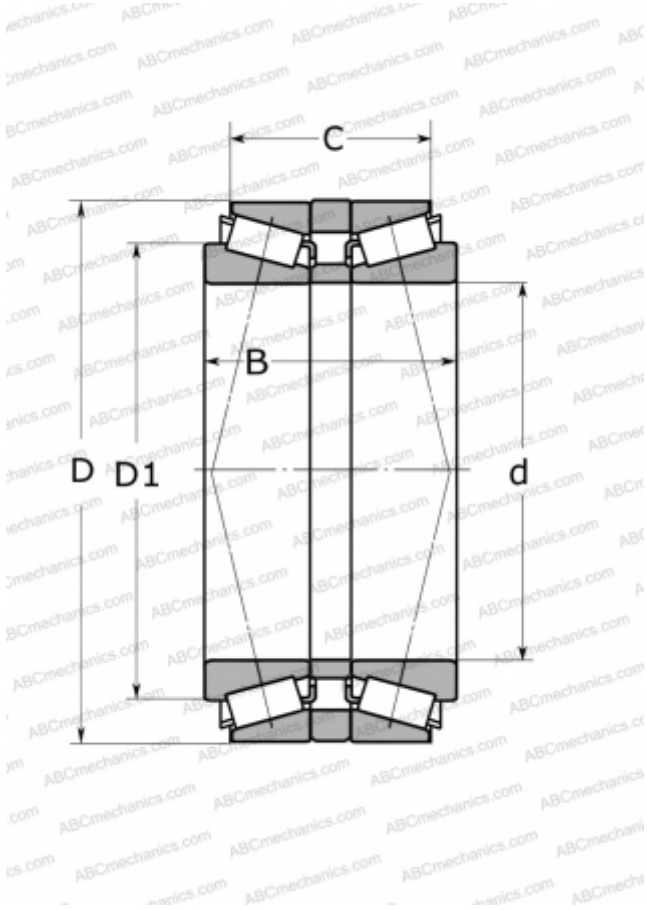

### Technical specification

#### DIMENSIONS, MM

d	120,000
D	215,000
D1	163,000
B	146,000
C	123,000

#### WEIGHT, KG

21,000

#### MANUFACTURER

[SKF](#)

#### CALCULATION DATA

Basic dynamic load rating, C	792,000 kN
Basic static load rating, Co	1400,000 kN
Fatigue load limit, Pu	146,000 kN
Reference speed	1800 r/min
Limiting speed	3000 r/min