

30226T97 SKF

Tapered roller bearings

TYPE: Roller bearings, Tapered, Single row, matched bearings, Back-to-back (SKF)

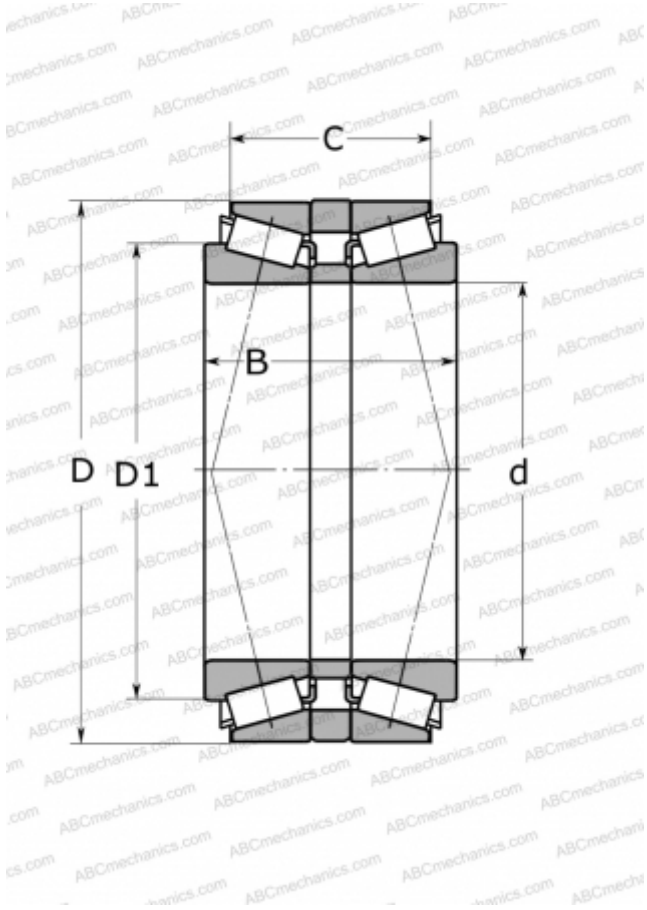

Technical specification

DIMENSIONS, MM

d	130,000
D	230,000
D1	173,000
B	97,500
C	78,000

WEIGHT, KG

15,000

MANUFACTURER

[SKF](#)

CALCULATION DATA

Basic dynamic load rating, C	627,000 kN
Basic static load rating, Co	980,000 kN
Fatigue load limit, Pu	106,000 kN
Reference speed	1700 r/min
Limiting speed	2800 r/min