

30228T106 J2/DB SKF

Tapered roller bearings

TYPE: Roller bearings, Tapered, Single row, matched bearings, Back-to-back (SKF)

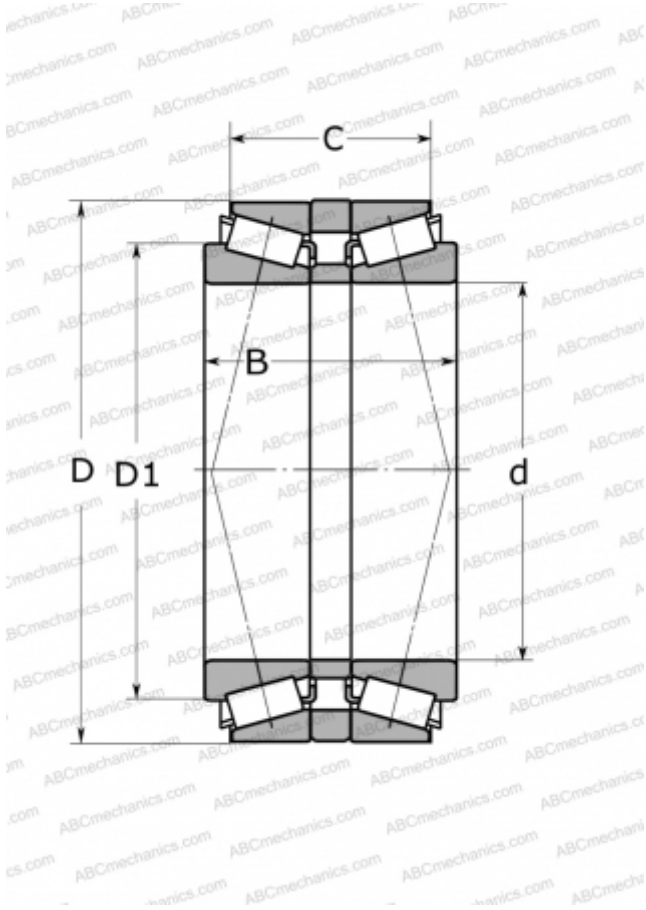

Technical specification

DIMENSIONS, MM

d	140,000
D	250,000
D1	186,000
B	106,000
C	86,500

WEIGHT, KG

19,500

MANUFACTURER

[SKF](#)

CALCULATION DATA

Basic dynamic load rating, C	721,000 kN
Basic static load rating, Co	1140,000 kN
Fatigue load limit, Pu	116,000 kN
Reference speed	1500 r/min
Limiting speed	2600 r/min