

32044T165 X/DB42C220 SKF

Tapered roller bearings

TYPE: Roller bearings, Tapered, Single row, matched bearings, Back-to-back (SKF)

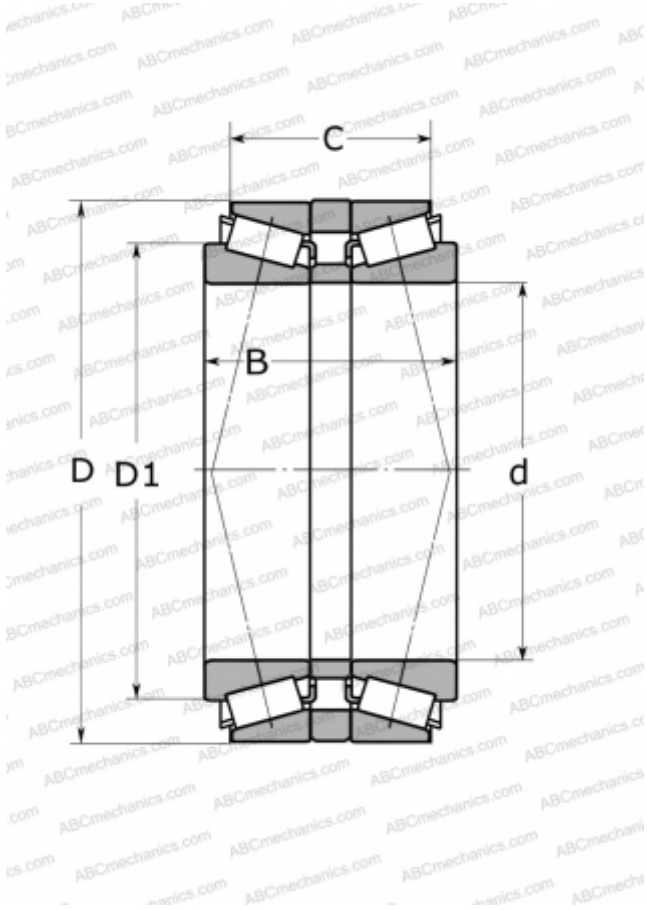

Technical specification

DIMENSIONS, MM

d	220,000
D	340,000
D1	279,000
B	165,000
C	127,000

WEIGHT, KG

52,000

MANUFACTURER

[SKF](#)

CALCULATION DATA

Basic dynamic load rating, C	1540,000 kN
Basic static load rating, Co	3550,000 kN
Fatigue load limit, Pu	300,000 kN
Reference speed	1000 r/min
Limiting speed	1700 r/min