

32048T172 X/DB SKF

Tapered roller bearings

TYPE: Roller bearings, Tapered, Single row, matched bearings, Back-to-back (SKF)

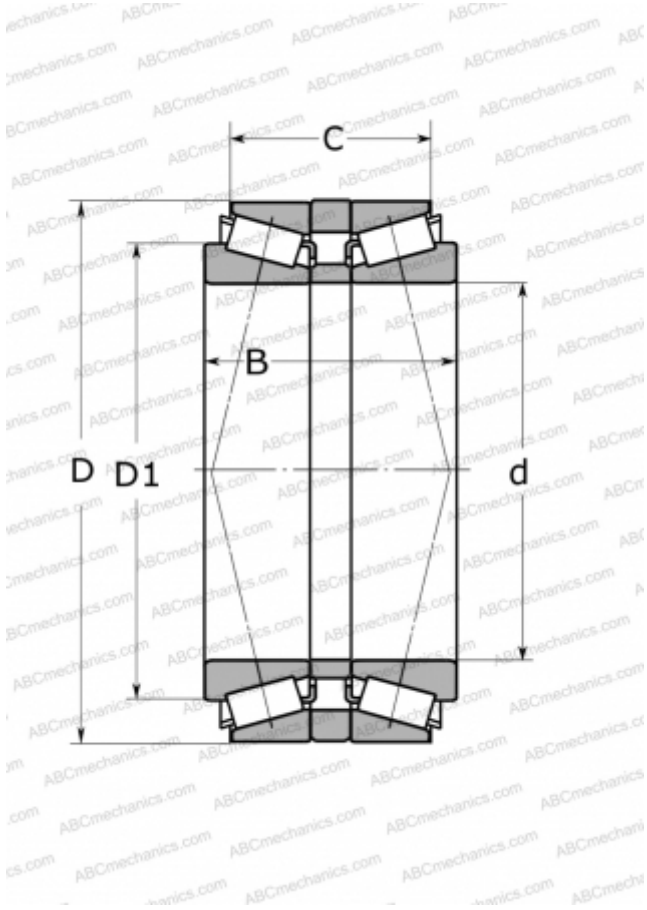

Technical specification

DIMENSIONS, MM

d	240,000
D	360,000
D1	299,000
B	172,000
C	134,000

WEIGHT, KG

56,000

MANUFACTURER

[SKF](#)

CALCULATION DATA

Basic dynamic load rating, C	1570,000 kN
Basic static load rating, Co	3550,000 kN
Fatigue load limit, Pu	315,000 kN
Reference speed	950 r/min
Limiting speed	1600 r/min