

32052T194 X/DB SKF

Tapered roller bearings

TYPE: Roller bearings, Tapered, Single row, matched bearings, Back-to-back (SKF)

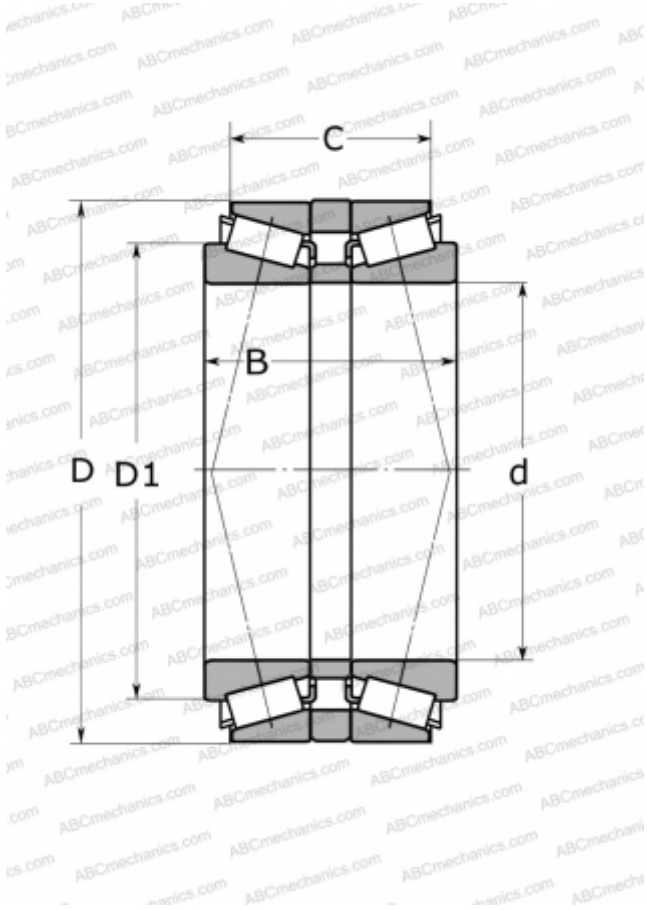

Technical specification

DIMENSIONS, MM

d	260,000
D	400,000
D1	328,000
B	194,000
C	150,000

WEIGHT, KG

80,500

MANUFACTURER

[SKF](#)

CALCULATION DATA

Basic dynamic load rating, C	1980,000 kN
Basic static load rating, Co	4400,000 kN
Fatigue load limit, Pu	380,000 kN
Reference speed	850 r/min
Limiting speed	1400 r/min