

## 22207 E SKF

Spherical roller bearings

TYPE: Roller bearings, Spherical, Double row, Radial, self-aligning

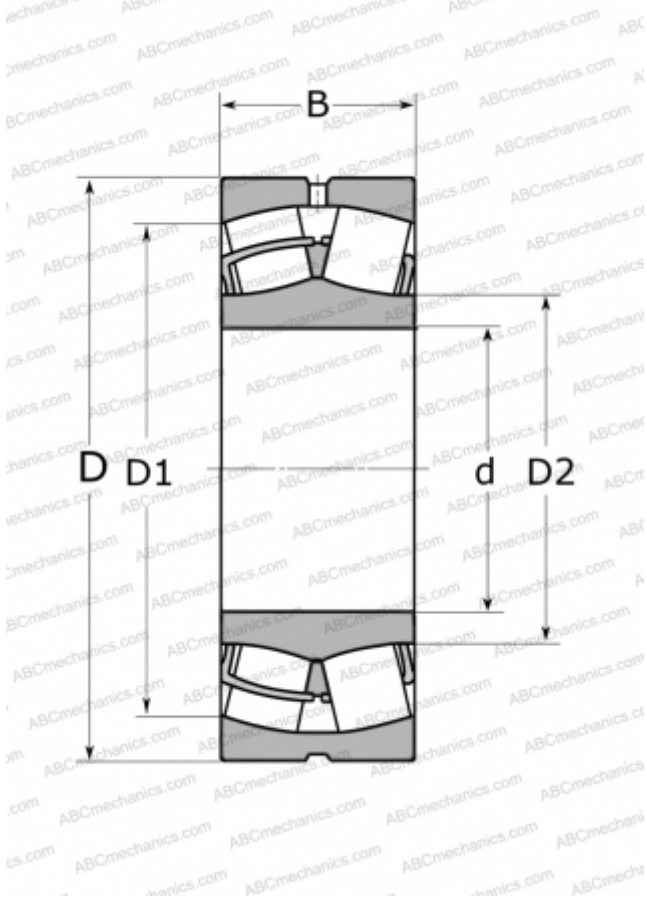

### Technical specification

#### DIMENSIONS, MM

d	35,000
D	72,000
D1	61,800
D2	44,500
B	23,000

#### WEIGHT, KG

0,450

#### MANUFACTURER

[SKF](#)

#### INTERCHANGE

ABC	<a href="#">22207 W33</a>
FAG	<a href="#">22207 ES TVPB</a>
TORRINGTON	<a href="#">22207(35 SD 22)</a>

#### CALCULATION DATA

Basic dynamic load rating, C	86,500 kN
Basic static load rating, Co	85,000 kN
Fatigue load limit, Pu	9,300 kN
Reference speed	9000 r/min
Limiting speed	12000 r/min