

22313 E SKF

Spherical roller bearings

TYPE: Roller bearings, Spherical, Double row, Radial, self-aligning

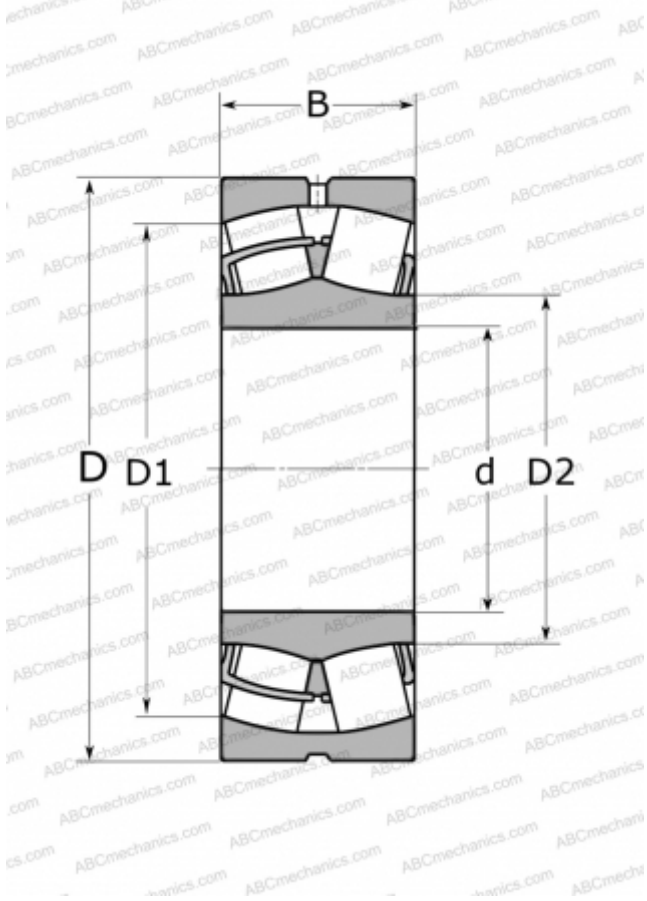

Technical specification

DIMENSIONS, MM

d	65,000
D	140,000
D1	118,000
D2	81,600
B	48,000

WEIGHT, KG

3,750

MANUFACTURER

[SKF](#)

INTERCHANGE

ABC	22313 W33
FAG	22313 ES TVPB
TORRINGTON	22313(65 SD 23)

CALCULATION DATA

Basic dynamic load rating, C	340,000 kN
Basic static load rating, Co	360,000 kN
Fatigue load limit, Pu	38,000 kN
Reference speed	3800 r/min
Limiting speed	5000 r/min