

21315 E SKF

Spherical roller bearings

TYPE: Roller bearings, Spherical, Double row, Radial, self-aligning

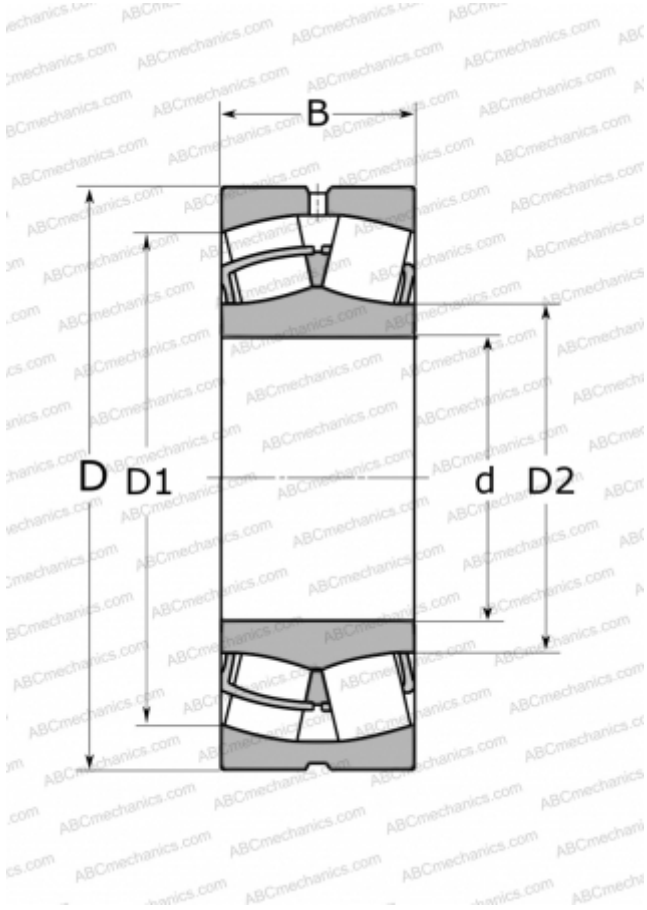

Technical specification

DIMENSIONS, MM

d	75,000
D	160,000
D1	133,000
D2	101,000
B	37,000

WEIGHT, KG

3,750

MANUFACTURER

[SKF](#)

INTERCHANGE

ABC	21315
FAG	21315 E TVPB
TORRINGTON	21315 VCSJ

CALCULATION DATA

Basic dynamic load rating, C	285,000 kN
Basic static load rating, Co	325,000 kN
Fatigue load limit, Pu	34,500 kN
Reference speed	4000 r/min
Limiting speed	5600 r/min