

23034 CC/W33 SKF

Spherical roller bearings

TYPE: Roller bearings, Spherical, Double row, Radial, self-aligning

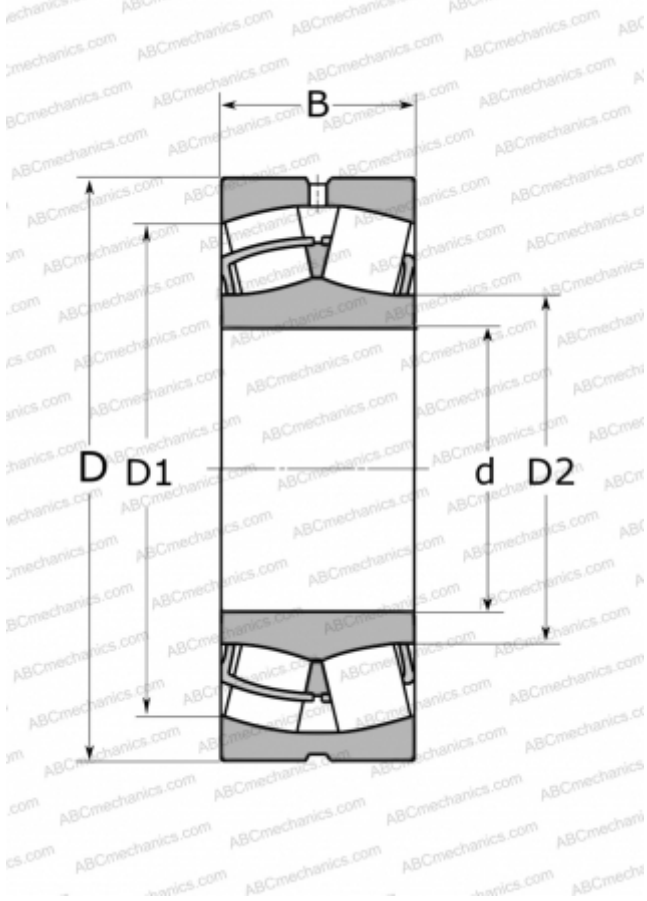

Technical specification

DIMENSIONS, MM

d	170,000
D	260,000
D1	232,000
D2	191,000
B	67,000

WEIGHT, KG

13,000

MANUFACTURER

[SKF](#)

INTERCHANGE

ABC	23034 W33
FAG	23034 S MB
TORRINGTON	23034(170 SD 30)

CALCULATION DATA

Basic dynamic load rating, C	710,000 kN
Basic static load rating, Co	1060,000 kN
Fatigue load limit, Pu	100,000 kN
Reference speed	2200 r/min
Limiting speed	2800 r/min