

23134 CC/W33 SKF

Spherical roller bearings

TYPE: Roller bearings, Spherical, Double row, Radial, self-aligning

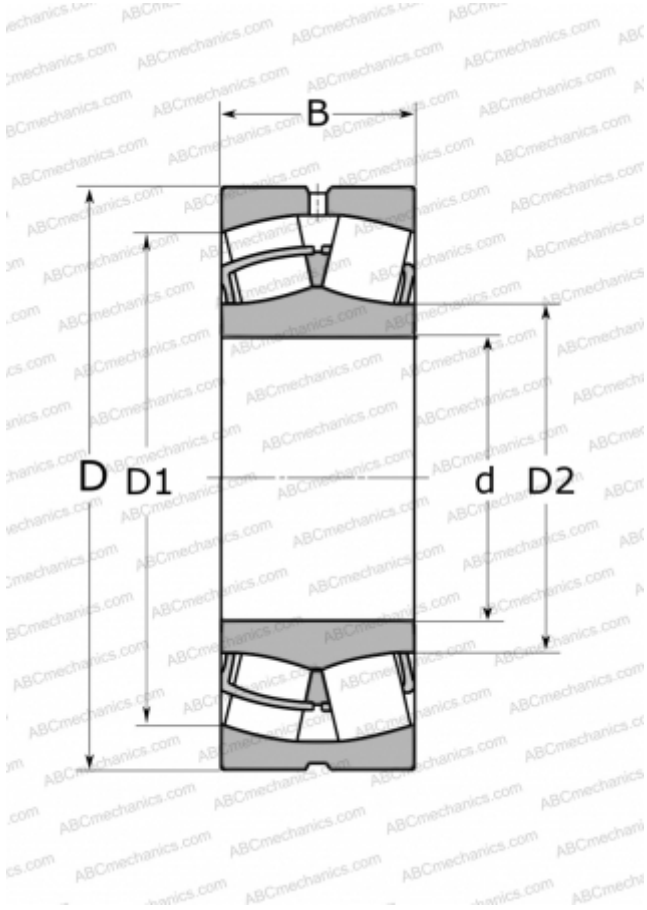

Technical specification

DIMENSIONS, MM

d	170,000
D	280,000
D1	244,000
D2	195,000
B	88,000

WEIGHT, KG

22,000

MANUFACTURER

[SKF](#)

INTERCHANGE

ABC	23134 W33
FAG	23134 S MB
TORRINGTON	23134(170 SD 31)

CALCULATION DATA

Basic dynamic load rating, C	1040,000 kN
Basic static load rating, Co	1500,000 kN
Fatigue load limit, Pu	137,000 kN
Reference speed	1800 r/min
Limiting speed	2400 r/min