

22336 CC/W33 SKF

Spherical roller bearings

TYPE: Roller bearings, Spherical, Double row, Radial, self-aligning

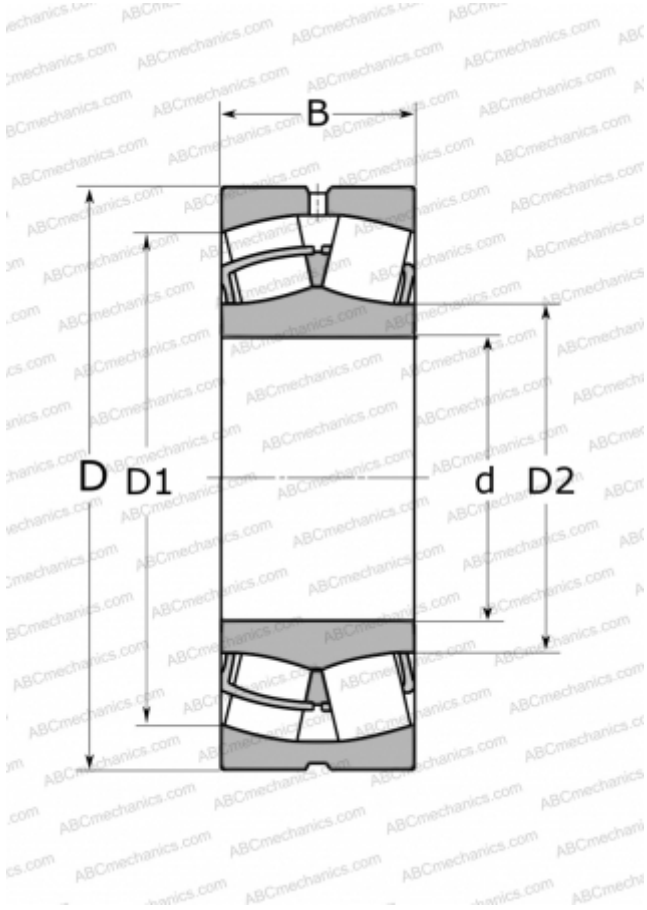

Technical specification

DIMENSIONS, MM

d	180,000
D	380,000
D1	317,000
D2	224,000
B	126,000

WEIGHT, KG

71,500

MANUFACTURER

[SKF](#)

INTERCHANGE

ABC	22336 W33
FAG	22336 MB
TORRINGTON	22336(180 SD 23)

CALCULATION DATA

Basic dynamic load rating, C	2000,000 kN
Basic static load rating, Co	2450,000 kN
Fatigue load limit, Pu	193,000 kN
Reference speed	1300 r/min
Limiting speed	1700 r/min