

23038 CC/W33 SKF

Spherical roller bearings

TYPE: Roller bearings, Spherical, Double row, Radial, self-aligning

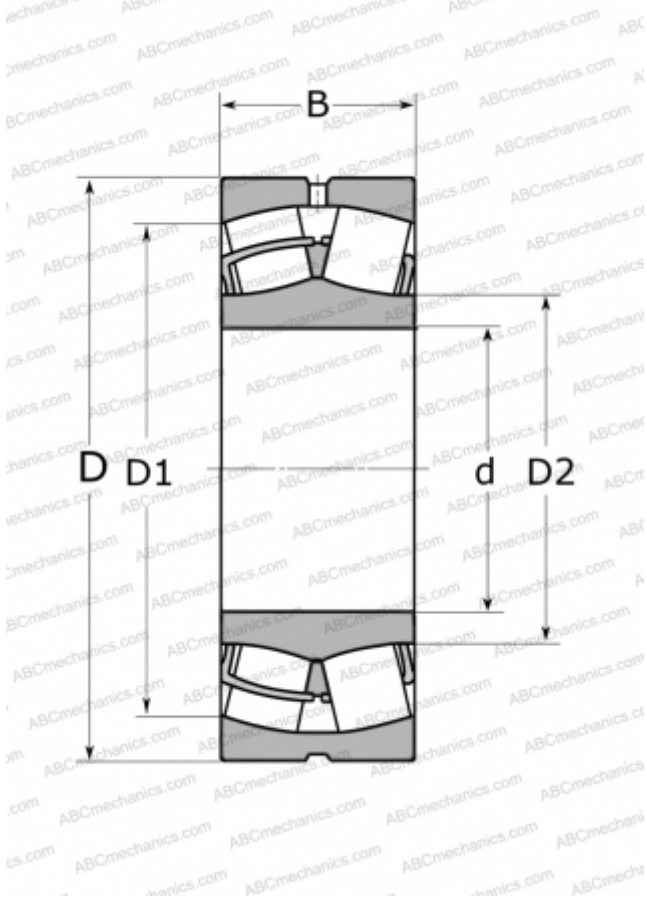

Technical specification

DIMENSIONS, MM

d	190,000
D	290,000
D1	261,000
D2	216,000
B	75,000

WEIGHT, KG

18,000

MANUFACTURER

[SKF](#)

INTERCHANGE

ABC	23038 W33
FAG	23038 S MB
TORRINGTON	23038(190 SD 30)

CALCULATION DATA

Basic dynamic load rating, C	865,000 kN
Basic static load rating, Co	1340,000 kN
Fatigue load limit, Pu	122,000 kN
Reference speed	1900 r/min
Limiting speed	2400 r/min