

23940 CC/W33 SKF

Spherical roller bearings

TYPE: Roller bearings, Spherical, Double row, Radial, self-aligning

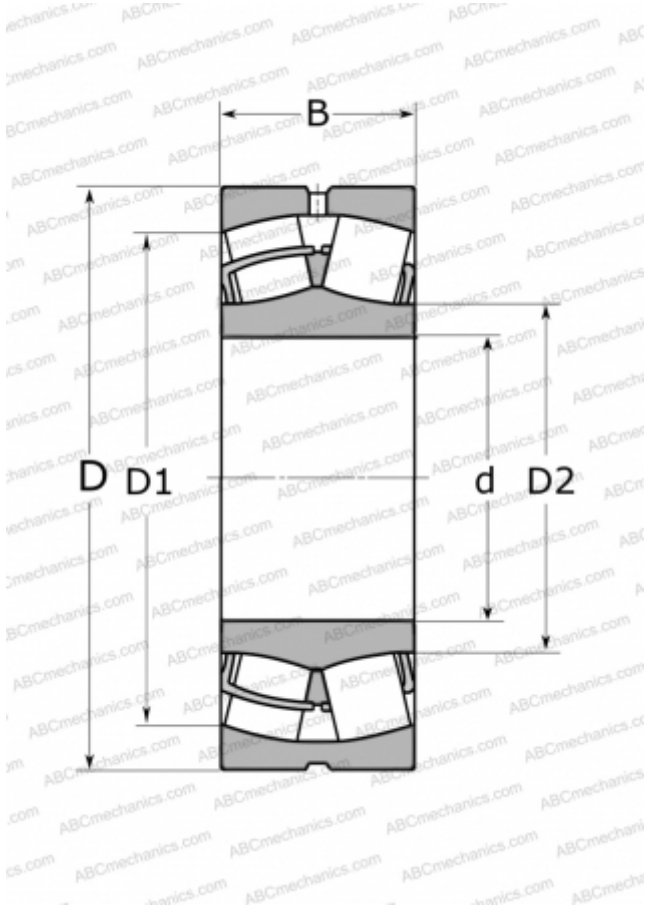

Technical specification

DIMENSIONS, MM

d	200,000
D	280,000
D1	258,000
D2	222,000
B	60,000

WEIGHT, KG

11,500

MANUFACTURER

[SKF](#)

INTERCHANGE

ABC	23940 W33
FAG	23940 S MB
TORRINGTON	23940(200 SD 39)

CALCULATION DATA

Basic dynamic load rating, C	546,000 kN
Basic static load rating, Co	1040,000 kN
Fatigue load limit, Pu	93,000 kN
Reference speed	2000 r/min
Limiting speed	2400 r/min