

23140 CC/W33 SKF

Spherical roller bearings

TYPE: Roller bearings, Spherical, Double row, Radial, self-aligning

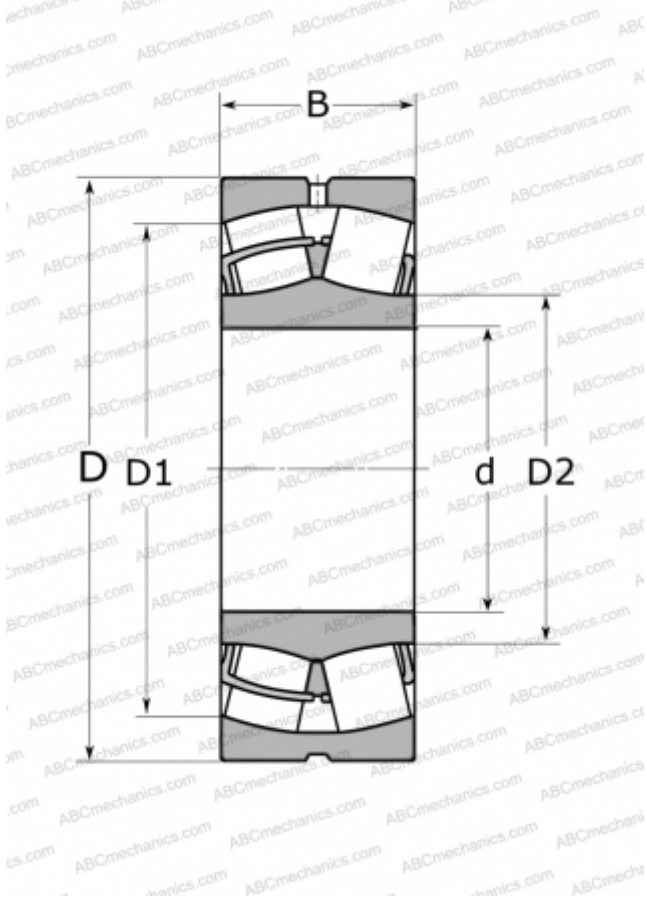

Technical specification

DIMENSIONS, MM

d	200,000
D	340,000
D1	293,000
D2	231,000
B	112,000

WEIGHT, KG

43,000

MANUFACTURER

[SKF](#)

INTERCHANGE

ABC	23140 W33
FAG	23140 B MB
TORRINGTON	23140(200 SD 31)

CALCULATION DATA

Basic dynamic load rating, C	1600,000 kN
Basic static load rating, Co	2360,000 kN
Fatigue load limit, Pu	204,000 kN
Reference speed	1500 r/min
Limiting speed	1900 r/min