

22206 EK SKF

Spherical roller bearings

TYPE: Roller bearings, Spherical, Double row, Radial, self-aligning, tapered bore

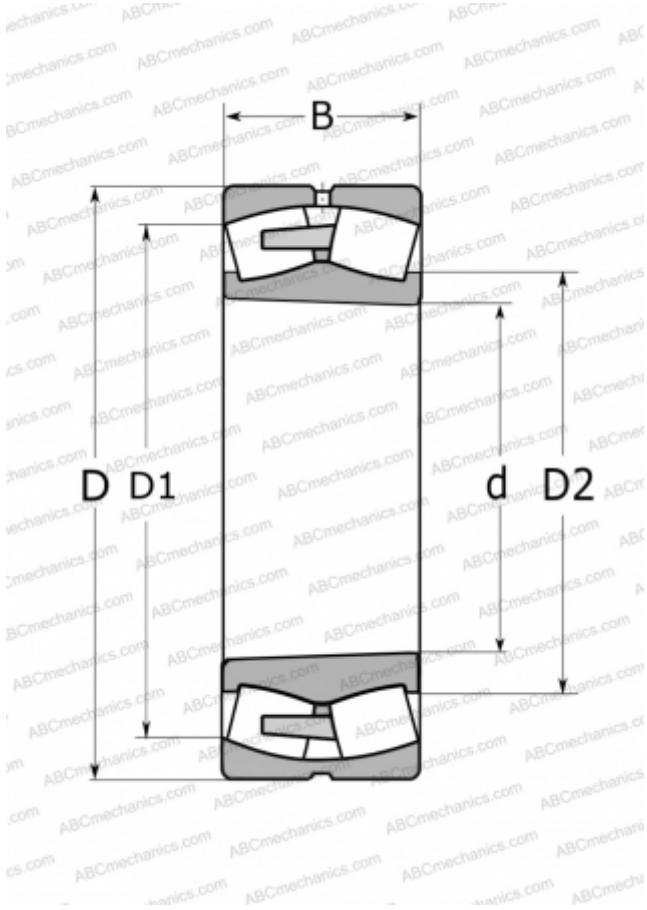

Technical specification

DIMENSIONS, MM

d	30,000
D	62,000
D1	53,000
D2	37,500
B	20,000

WEIGHT, KG

0,290

MANUFACTURER

[SKF](#)

CALCULATION DATA

Basic dynamic load rating, C	64,000 kN
Basic static load rating, Co	60,000 kN
Fatigue load limit, Pu	6,400 kN
Reference speed	10000 r/min
Limiting speed	14000 r/min