

21308 EK SKF

Spherical roller bearings

TYPE: Roller bearings, Spherical, Double row, Radial, self-aligning, tapered bore

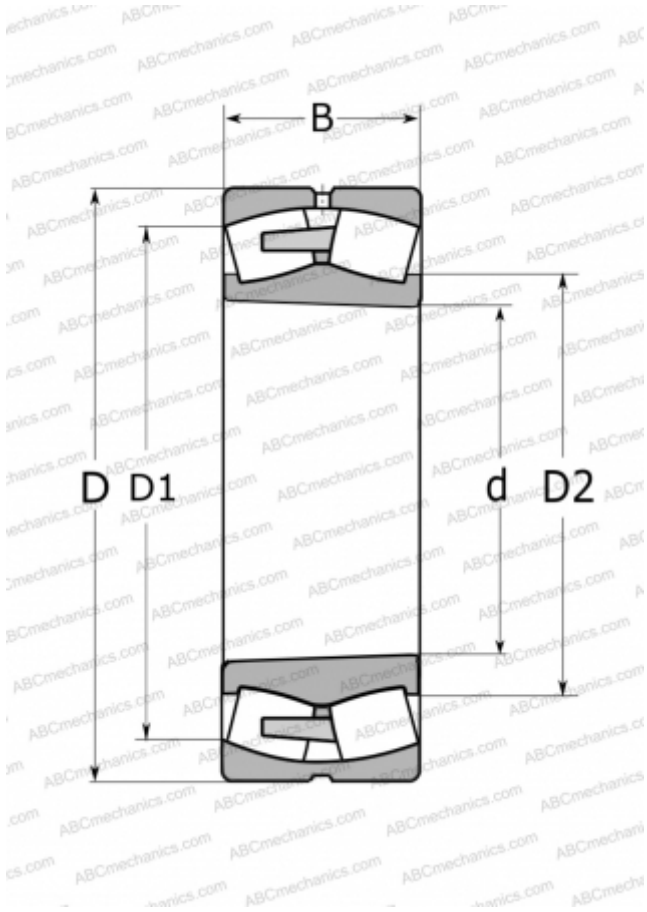

Technical specification

DIMENSIONS, MM

d	40,000
D	90,000
D1	79,800
D2	59,900
B	23,000

WEIGHT, KG

0,750

MANUFACTURER

[SKF](#)

CALCULATION DATA

Basic dynamic load rating, C	104,000 kN
Basic static load rating, Co	108,000 kN
Fatigue load limit, Pu	11,800 kN
Reference speed	7000 r/min
Limiting speed	9500 r/min