

21309 EK SKF

Spherical roller bearings

TYPE: Roller bearings, Spherical, Double row, Radial, self-aligning, tapered bore

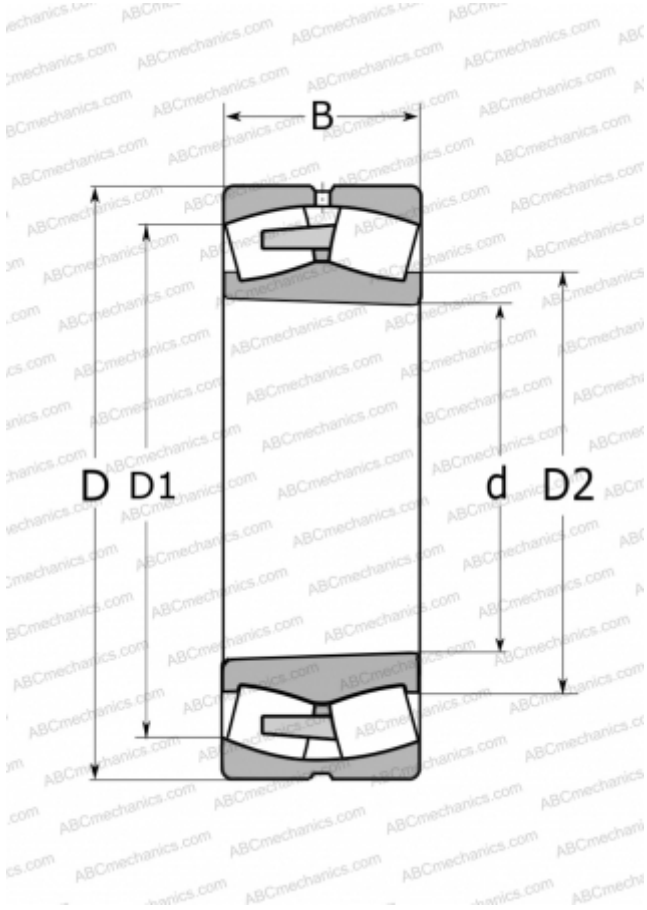

Technical specification

DIMENSIONS, MM

d	45,000
D	100,000
D1	88,000
D2	65,300
B	25,000

WEIGHT, KG

0,990

MANUFACTURER

[SKF](#)

CALCULATION DATA

Basic dynamic load rating, C	125,000 kN
Basic static load rating, Co	127,000 kN
Fatigue load limit, Pu	13,700 kN
Reference speed	6300 r/min
Limiting speed	8500 r/min