

22312 EK SKF

Spherical roller bearings

TYPE: Roller bearings, Spherical, Double row, Radial, self-aligning, tapered bore

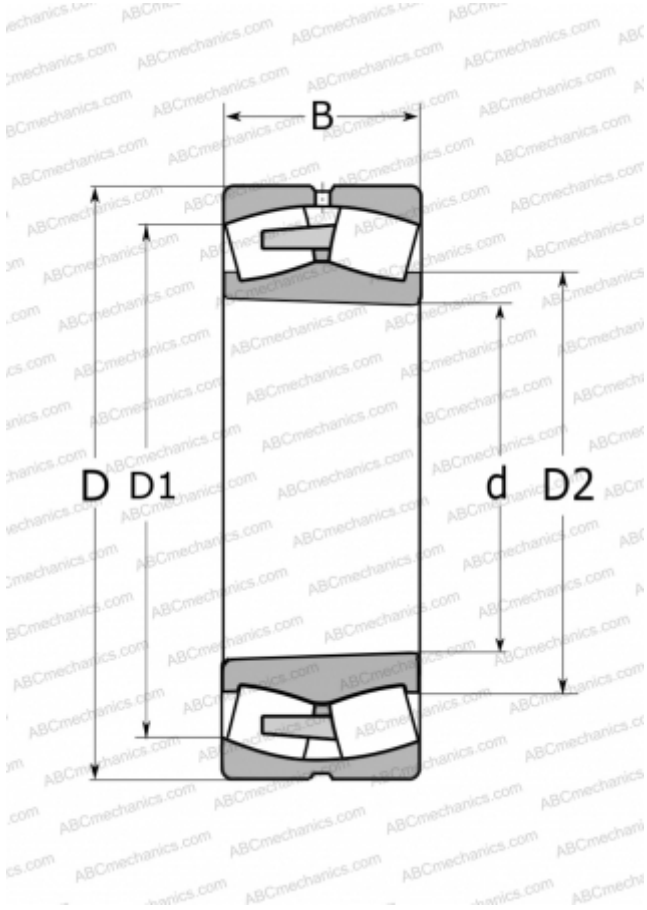

Technical specification

DIMENSIONS, MM

d	60,000
D	130,000
D1	110,000
D2	77,900
B	46,000

WEIGHT, KG

3,100

MANUFACTURER

[SKF](#)

CALCULATION DATA

Basic dynamic load rating, C	310,000 kN
Basic static load rating, Co	335,000 kN
Fatigue load limit, Pu	36,500 kN
Reference speed	4000 r/min
Limiting speed	5300 r/min