

22316 EK SKF

Spherical roller bearings

TYPE: Roller bearings, Spherical, Double row, Radial, self-aligning, tapered bore

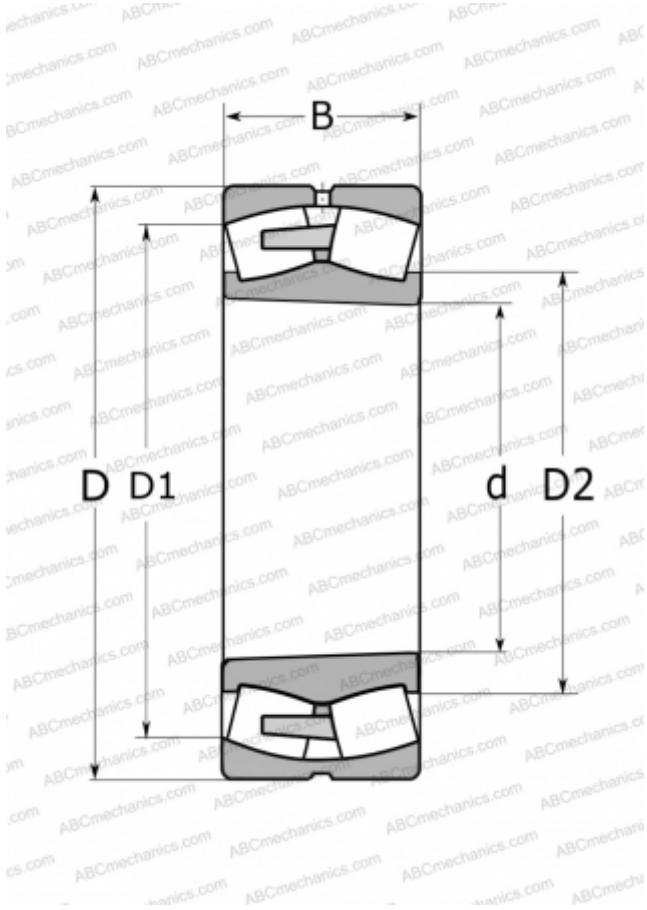

Technical specification

DIMENSIONS, MM

d	80,000
D	170,000
D1	143,000
D2	98,300
B	58,000

WEIGHT, KG

6,600

MANUFACTURER

[SKF](#)

CALCULATION DATA

Basic dynamic load rating, C	490,000 kN
Basic static load rating, Co	540,000 kN
Fatigue load limit, Pu	54,000 kN
Reference speed	3000 r/min
Limiting speed	4000 r/min